

# C-HB-A-LB2 Series

Linear LED High Bay Light | Field Selectable CCT & Wattage  
Replaces up to 8-Lamp T5HO 54W



## ENDLESS OPTIONS TO SUIT YOUR NEEDS

These linear high bay LEDs are an ideal source for energy efficient, low-maintenance lighting in large spaces such as gymnasiums, warehouses, or retail and industrial locations. With CCT & Wattage Selectable options, these highly configurable units are cULus Listed for damp locations. They offer up to 42,700 lumens, emergency back-up availability, and a 6-foot cord option. Four accessories sold separately: plug & play motion sensor, 3, 6, and 12-foot chain suspension kits. Available in 120-277V or 277-480V options and feature an enclosed light bar to prevent dust and bug intrusion. Outside light bars pivot up to 180° for up-lighting or wider light distribution. Simple, tool-less entry to the wiring compartment make these high bays simple to install and maintain. Included 5-year warranty.



## PRODUCT SPECIFICATIONS

### OVERVIEW

- Initial Delivered Lumens: Up to 26,200 Lumens (**S24L**), Up to 42,700 Lumens (**S42L**)
- CRI: ≥ 80
- CCT: Field Selectable (4000K/4500K/5000K)
- Max. Input Power: 180W (**S24L**), 290W (**S42L**)
- Dimmable: 0-10V dimming to 10%, dims to off
- Operating Temperature Range: -40°F to 122°F (-40°C to 50°C) (**w/o EB**), 32°F to 122°F (0°C to 50°C) (**w/ EB**)
- Replaces: 6-Lamp - T5HO 54W (**S24L**), 8-Lamp - T5HO 54W (**S42L**)
- Estimated L<sub>70</sub> Lifetime @ 25°C: > 100,000 hours
- Power Factor: > 0.9 at full load
- Total Harmonic Distortion: < 20% at full load
- Limited Warranty: 5-Year\*

FEATURES	RECOMMENDED USE	INPUT VOLTAGE
<ul style="list-style-type: none"> <li>4000K, 4500K or 5000K color temperature options</li> <li>Enclosed LED light bar design prevents dust and bug intrusion</li> <li>Tool-less entry to wiring compartment simplifies installation</li> <li>Four 1/2" knockouts, three 3/4" knockouts</li> </ul>	<ul style="list-style-type: none"> <li>Warehouse</li> <li>Industrial</li> <li>Retail</li> <li>Gymnasium</li> </ul>	<ul style="list-style-type: none"> <li>UL: Universal Voltage (120 through 277V Operation)</li> <li>UH: Universal Voltage (277 through 480V Operation)</li> </ul>

## ORDERING INFORMATION

Example SKU: C-HB-A-LB2-S42L-SCCT-UL-WH-EB-C6

C-HB	A	LB2		SCCT		WH		
PRODUCT	SERIES	TYPE	LUMEN PACKAGE*	FIELD SELECTABLE CCT	VOLTAGE	HOUSING COLOR	EMERGENCY BACKUP OPTION	CORD OPTION
C-HB	A	LB2 Light Bar, 2-foot length	<b>S24L</b> Up to 26,200 Lumens (180W)  <b>S42L</b> Up to 42,700 Lumens (290W)	<b>SCCT</b> Neutral White (4000K) White (4500K) Cool White (5000K)	<b>UL</b> Universal Voltage (120-277V Operation)  <b>UH</b> Universal Voltage (277-480V Operation)	WH White	<b>[BLANK]</b> Non-EB  <b>EB</b> 20W Emergency battery backup - Provides 90 minutes of light output in EM mode - Available only with UL voltage	<b>[BLANK]</b> No Cord  <b>C6</b> 6-foot, 5-wire cord - 300V (UL) 600V (UH)

\*Default settings at time of shipping are highest product wattage and 4500K.

### CERTIFICATIONS:



# C-HB-A-LB2 Series

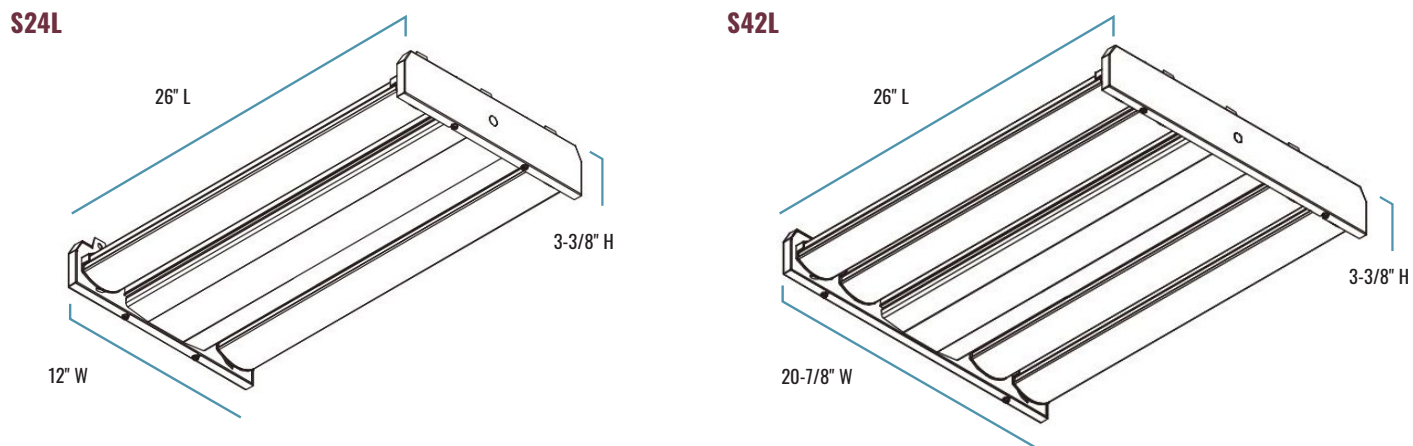

## SERIES OVERVIEW

DIMENSIONS	PRODUCT WEIGHT	MOUNTING HEIGHT	SPACING
26" L x 12" W x 3-3/8" H (C-HB-A-LB2-S24L-SCCT-UL-WH)	8.3 lbs.	15-25 feet	1 to 1-1/2 times the mounting height
26" L x 20-7/8" W x 3-3/8" H (C-HB-A-LB2-S42L-SCCT-UL-WH)	11.5 lbs.	25+ feet	
26" L x 12" W x 3-3/8" H (C-HB-A-LB2-S24L-SCCT-UH-WH)	8.5 lbs.	15-25 feet	
26" L x 20-7/8" W x 3-3/8" H (C-HB-A-LB2-S42L-SCCT-UH-WH)	12 lbs.	25+ feet	
26" L x 12" W x 3-3/8" H (C-HB-A-LB2-S24L-SCCT-UL-WH-EB)	9.6 lbs.	15-25 feet	
26" L x 20-7/8" W x 3-3/8" H (C-HB-A-LB2-S42L-SCCT-UL-WH-EB)	12.8 lbs.	25+ feet	
26" L x 12" W x 3-3/8" H (C-HB-A-LB2-S24L-SCCT-UL-WH-C6)	8.82 lbs.	15-25 feet	
26" L x 20-7/8" W x 3-3/8" H (C-HB-A-LB2-S42L-SCCT-UL-WH-C6)	12 lbs.	25+ feet	
26" L x 12" W x 3-3/8" H (C-HB-A-LB2-S24L-SCCT-UH-WH-C6)	9.02 lbs.	15-25 feet	
26" L x 20-7/8" W x 3-3/8" H (C-HB-A-LB2-S42L-SCCT-UH-WH-C6)	12.5 lbs.	25+ feet	
26" L x 12" W x 3-3/8" H (C-HB-A-LB2-S24L-SCCT-UL-WH-EB-C6)	10.2 lbs.	15-25 feet	
26" L x 20-7/8" W x 3-3/8" H (C-HB-A-LB2-S42L-SCCT-UL-WH-EB-C6)	13.3 lbs.	25+ feet	

## FIXTURE SPECIFICATIONS

<b>HOUSING</b>	Housing frame is stamped aluminum with a high reflectance, white powder-coat finish. Light bar housings and wiring compartment made from extruded aluminum.
<b>LENS ASSEMBLY</b>	Polycarbonate. Outside light bars on product pivot up to 180° for up-lighting or wider light distribution.
<b>MOUNTING</b>	V-Hooks (2) included, chains sold separately. Pendant/conduit mount supplied by others.



# C-HB-A-LB2 Series

## LUMINAIRE AND ELECTRICAL PERFORMANCE





OPERATING TEMPERATURE RANGE	ESTIMATED L <sub>70</sub> LIFETIME @ 25°C (77°F)	SURGE PROTECTION	POWER FACTOR	TOTAL HARMONIC DISTORTION
-40°F to 122°F (-40°C to 50°C) (w/o EB) 32°F to 122°F (0°C to 50°C) (w/ EB)	> 100,000 Hours	6kV	>0.9 at full load	<20% at full load

LUMEN PACKAGE	INITIAL DELIVERED LUMENS			SYSTEM WATTS	CURRENT DRAW (AMPS)					
	4000K	4500K	5000K		120V	208V	240V	277V	347V	480V
S24L	24,200	26,200	24,200	180W	1.50	0.87	0.75	0.65	0.52	0.38
	18,100	19,600	18,200	125W	1.04	0.60	0.52	0.45	0.36	0.26
	12,800	13,825	12,850	85W	0.71	0.41	0.35	0.31	0.24	0.18
S42L	39,500	42,700	41,700	290W	2.42	1.39	1.21	1.05	0.84	0.60
	35,000	37,900	37,000	240W	2.00	1.15	1.00	0.87	0.69	0.50
	30,900	33,400	32,600	205W	1.71	0.99	0.85	0.74	0.59	0.43

## WARRANTY AND CERTIFICATIONS



WARRANTY	cULus LISTED	DLC
5-Year Limited*	Damp Locations	5.1 Premium Refer to <a href="https://www.designlights.org/search/">https://www.designlights.org/search/</a> for most current information.

## ACCESSORIES For use with C-HB-A-LB2 Series only

	<b>PIR MOTION SENSOR   PLUG &amp; PLAY</b>
	<b>SKU:</b> C-HB-A-LB2-ACC-PIR
	<b>3-FOOT CHAIN SUSPENSION KIT   STEEL</b>
	<b>SKU:</b> C-ACC-A-CHAIN-3FT
	<b>6-FOOT CHAIN SUSPENSION KIT   STEEL</b>
	<b>SKU:</b> C-ACC-A-CHAIN-6FT
	<b>12-FOOT CHAIN SUSPENSION KIT   STEEL</b>
	<b>SKU:</b> C-ACC-A-CHAIN-12FT

# C-HB-A-LB2 Series

## ACCESSORIES For use with C-HB-A-LB2 Series only

	<b>6-FOOT CORD &amp; 120V 3-BLADE TWIST-LOCK PLUG</b>
	<b>SKU:</b> C-ACC-A-CRDS-6FT-LV-TL
	<b>6-FOOT CORD &amp; 120V STRAIGHT BLADE PLUG</b>
	<b>SKU:</b> C-ACC-A-CRDS-6FT-LV-SB
	<b>6-FOOT CORD &amp; 277V 3-BLADE TWIST LOCK PLUG*</b>
	<b>SKU:</b> C-ACC-A-CRDS-6FT-HV-TL
	<b>6-FOOT CORD &amp; 208/240V 3-BLADE TWIST LOCK PLUG</b>
	<b>SKU:</b> C-ACC-A-CRDS-6FT-MV-TL
	<b>120V 3-WIRE TWIST-LOCK RECEPTACLE</b>
	<b>SKU:</b> C-ACC-A-RECEP-LV-TL
	<b>277V 3-WIRE TWIST-LOCK RECEPTACLE*</b>
	<b>SKU:</b> C-ACC-A-RECEP-HV-TL
	<b>208/240V 3-WIRE TWIST-LOCK RECEPTACLE</b>
	<b>SKU:</b> C-ACC-A-RECEP-MV-TL

\*Not for use with 347 or 480V.

© 2023 Cree Lighting, A company of IDEAL INDUSTRIES. All rights reserved. For informational purposes only. Content is subject to change. Patent [www.creelighting.com/patents](http://www.creelighting.com/patents). C-Lite and the C-Lite logo are registered trademarks of Cree Lighting. Due to continuous product improvement, information in this document is subject to change. The cULus logo is a registered trademark of UL LLC. The DLC QPL and DLC QPL Premium Logos are the registered and unregistered trademarks of Efficiency Forward, Inc.

**US:** [creelighting.com](http://creelighting.com), [e-conolight.com](http://e-conolight.com)      **Distribution/Sales:** 855-617-2733      **Customer Service:** 888-243-9445

Rev. Date: 06/26/2023      For informational purposes only. Content is subject to change. \*See [lighting.cree.com/warranty](http://lighting.cree.com/warranty) for details

**C-LITE**  
LED LIGHTING